

ALGO



Paging Adapter Amplifier Integration Guide

- **Paging Adapter Hardware Interface**
 - **8301 Paging Adapter & Scheduler.....6**
 - **8373 Zone Paging Adapter.....7**
 - **Hybrid IP & Analog Infrastructure Integration.....9**

- **Paging Amplifier Wiring Diagrams**
 - **Adastra RM60/120/240S with 8301.....11**
 - **Adastra RM60/120/240S with 8373.....12**
 - **AT&T/Lucent PagePal with 8301.....13**
 - **AT&T PagePac 20 PowerMate14**
 - **Bogen C35/C60/C100 with 8301.....15**
 - **Bogen GS35/GS60/GS100/GS150/GS250 with 8301.....16**
 - **Bogen PCM2000 with 8301.....17**
 - **Bogen TPU-35/60/100/250 with 8301.....18**
 - **Bogen TPU-35/60/100/250 with 8373.....19**

➤ **Paging Amplifier Wiring Diagrams (continued)**

- **Bogen UTI with 8301.....20**
- **Crown 135MA/160MA with 8301.....21**
- **Crown CDI 1000/2000/4000 with 8301.....22**
- **Inter-M PA-920/935 with 8301.....23**
- **Inter-M PA-60/120/240 with 8301.....24**
- **Paso 3000 Series with 8301.....25**
- **TOA BG-115/130 with 8301.....26**
- **TOA BG-220/235 with 8301.....27**
- **TOA BG-1015/1030/1060/1120 with 8301.....28**
- **TOA BG-2035/2060/2120 with 8301.....29**
- **TOA 500 Series with 8301.....30**
- **Valcom V-2000a with 8301.....31**

➤ **Paging Amplifier Wiring Diagrams (continued)**

- **Valcom V-2001a with 8301.....32**
- **Valcom V-2003A with 8301.....33**
- **Valcom V-2006A with 8301.....34**
- **Valcom V-9940 with 8301.....35**
- **Valcom V-9941A with 830136**
- **Valcom V-1094A with 8301..... 37**
- **Valcom V-2924A with 830138**
- **Valcom VIP-801A with 830139**
- **Viking PA-2A with 8301.....40**
- **Viking PA-15 with 8301.....41**
- **Viking PA-60 with 8301.....42**

ALGO

Paging Adapter Hardware Interface

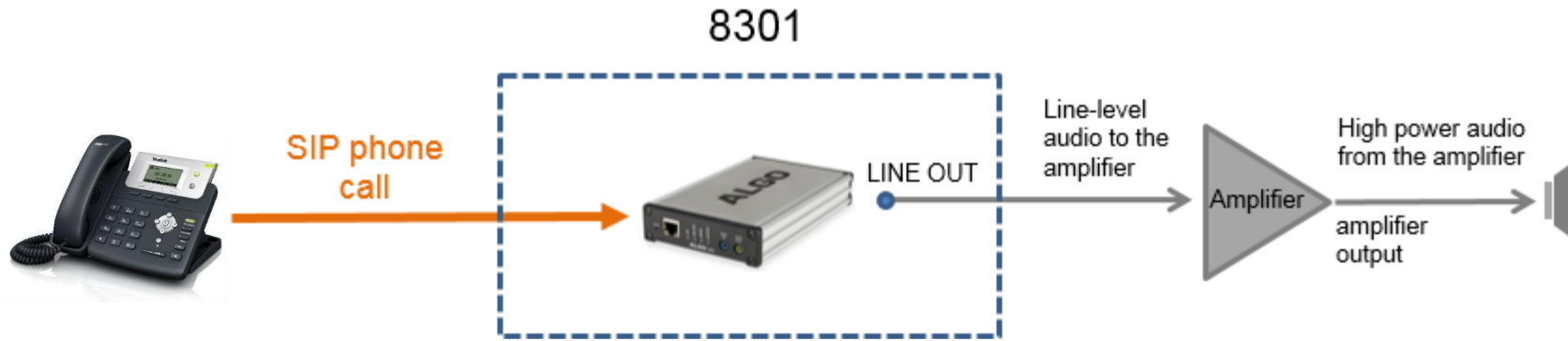

- SIP (50 Page ext., 10 Emergency Alert ext. & 10 Ring ext.)
- Multicast Send & Receive
- Scheduler for Automated Tones & Announcements
- 1GB Memory



Front View

Music Input



Rear View

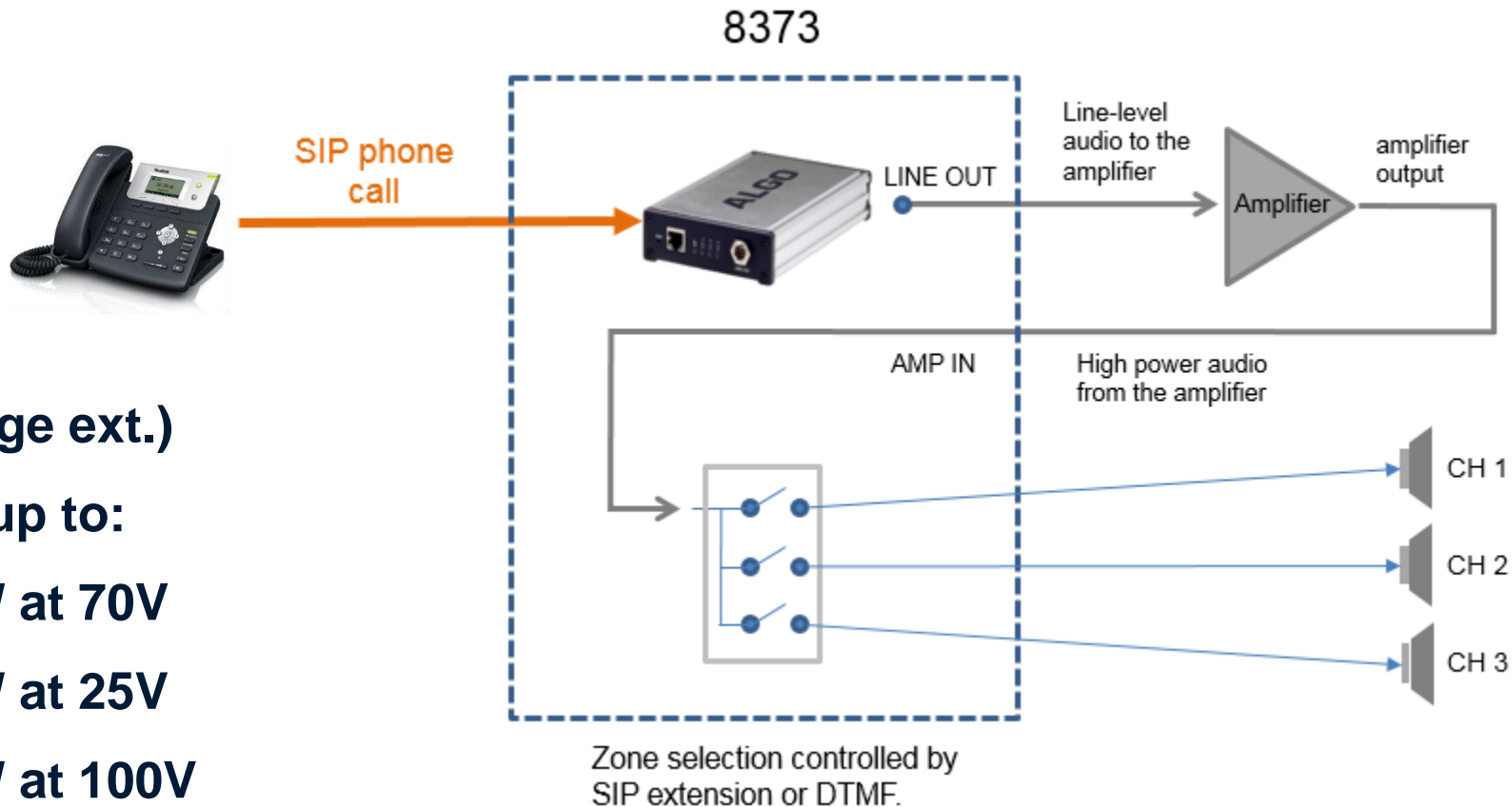

- **SIP (50 Page ext.)**
- **Switches up to:**
 - **500W at 70V**
 - **180W at 25V**
 - **720W at 100V**
- **Multicast Send & Receive**

8373 Zone Paging Adapter



Front View

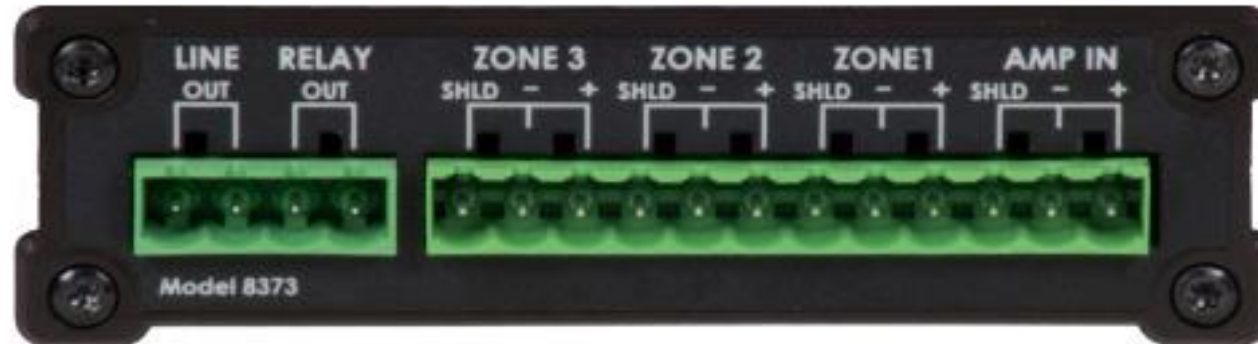

Rear View

Hybrid IP & Analog Infrastructure Integration



Paging Amplifier Wiring Diagrams

8301 Installation Example with Adastra RM60/120/240S

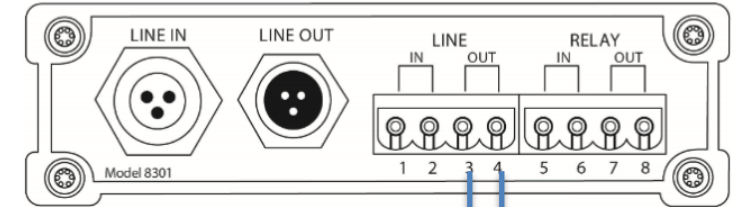

Recommended: use an aux cable and strip the leads on one end. Connect the positive and negative (usually red and black) terminals to the Line Out.

To connect the other end to the amplifier input Mic/Line 2, use a 3.5 mm to 6.3 mm adapter.



On the 8301 web interface, go to Basic Settings -> Features and set the Line Out Analog Output Level to "0dBm 600 ohm (0.775 Vrms)".

8373 Installation Example with Adastra RM60/120/240S

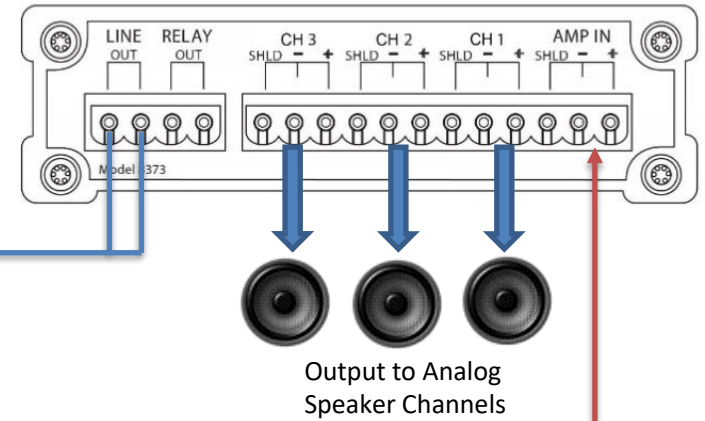

Output from
Amplifier
(25/70/100V)

Output to Analog
Speaker Channels

Recommended: use an aux cable and strip the leads on one end. Connect the positive and negative (usually red and black) terminals to the Line Out.

To connect the other end to the amplifier input Mic/Line 2, use a 3.5 mm to 6.3 mm adapter.

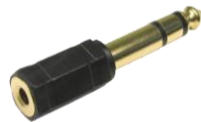

On the 8301 web interface, go to Basic Settings -> Features and set the Line Out Analog Output Level to "0dBm 600 ohm (0.775 Vrms)".

8301 Installation Example with AT&T/Lucent PagePal

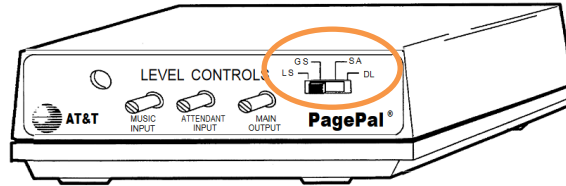
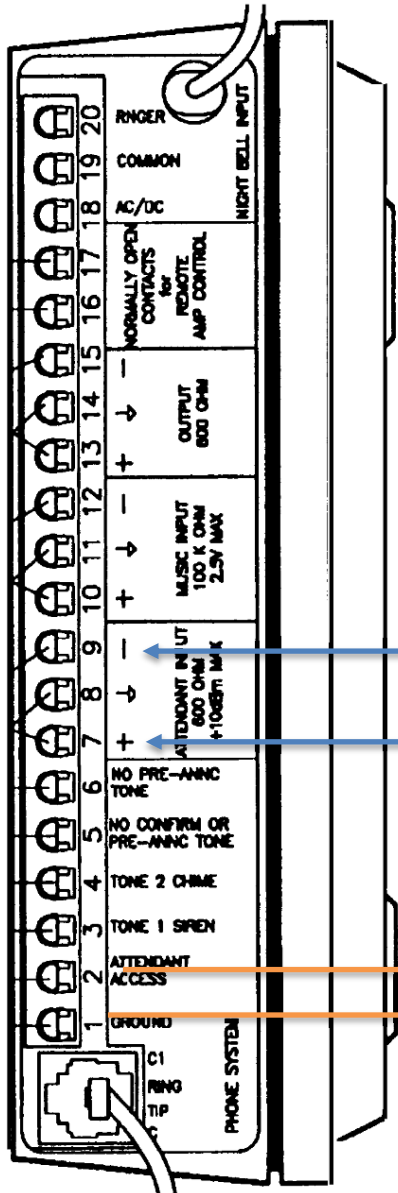

Set the PagePal to DL (Dry Loop) mode using the switch in the front

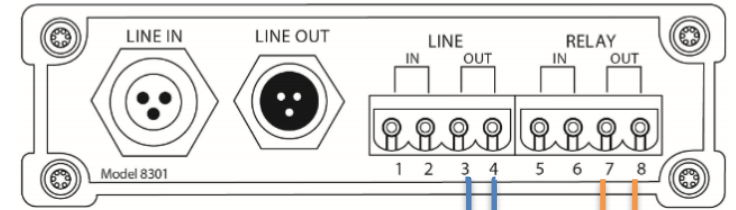

On the 8301 web interface, go to Basic Settings -> Features and set the Line Out Analog Output Level to "0dBm 600 ohm (0.775 Vrms)".

8301 Installation Example with AT&T PagePac 20 PowerMate

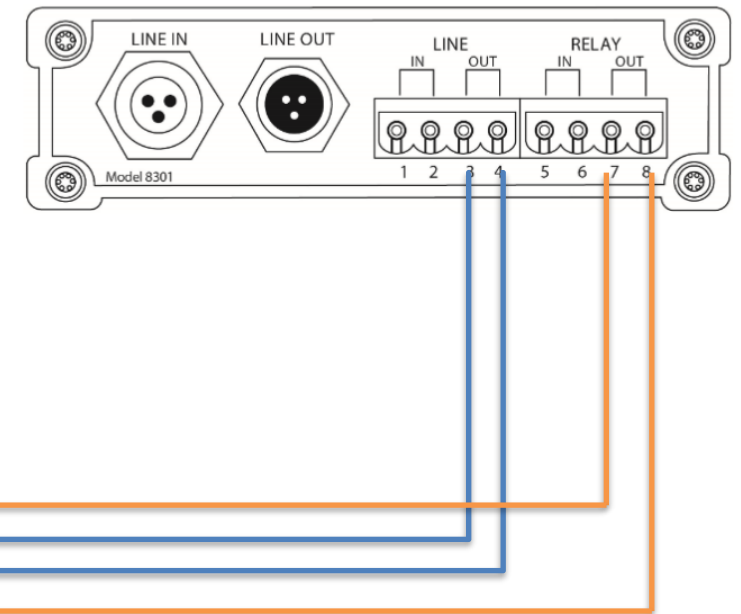
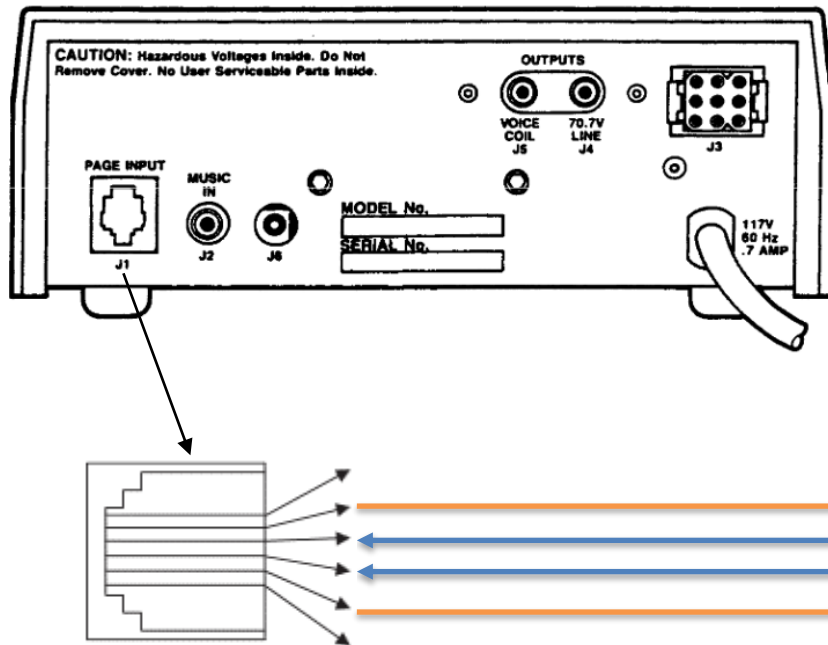

On the 8301 web interface, go to Basic Settings -> Features and set the Line Out Analog Output Level to "0dBm 600 ohm (0.775 Vrms)".

8301 Installation Example with Bogen C35/C60/C100

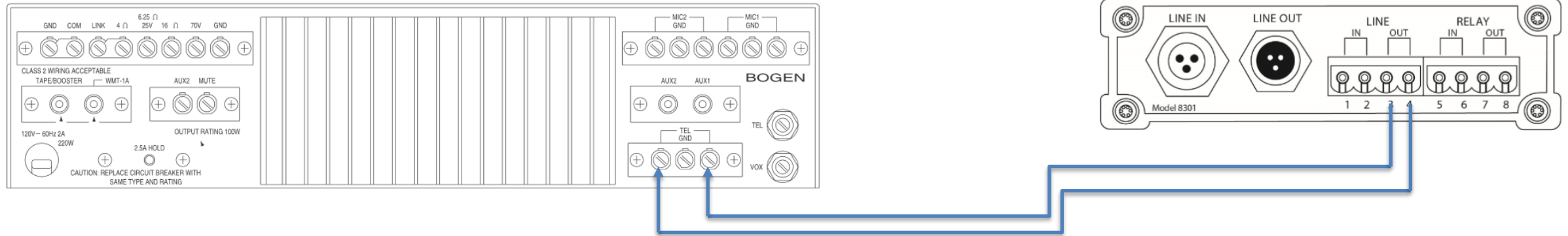

On the 8301 web interface, go to Basic Settings -> Features and set the Line Out Analog Output Level to "0dBm 600 ohm (0.775 Vrms)".

8301 Installation Example with Bogen GS35/GS60/GS100 & GS150/GS250

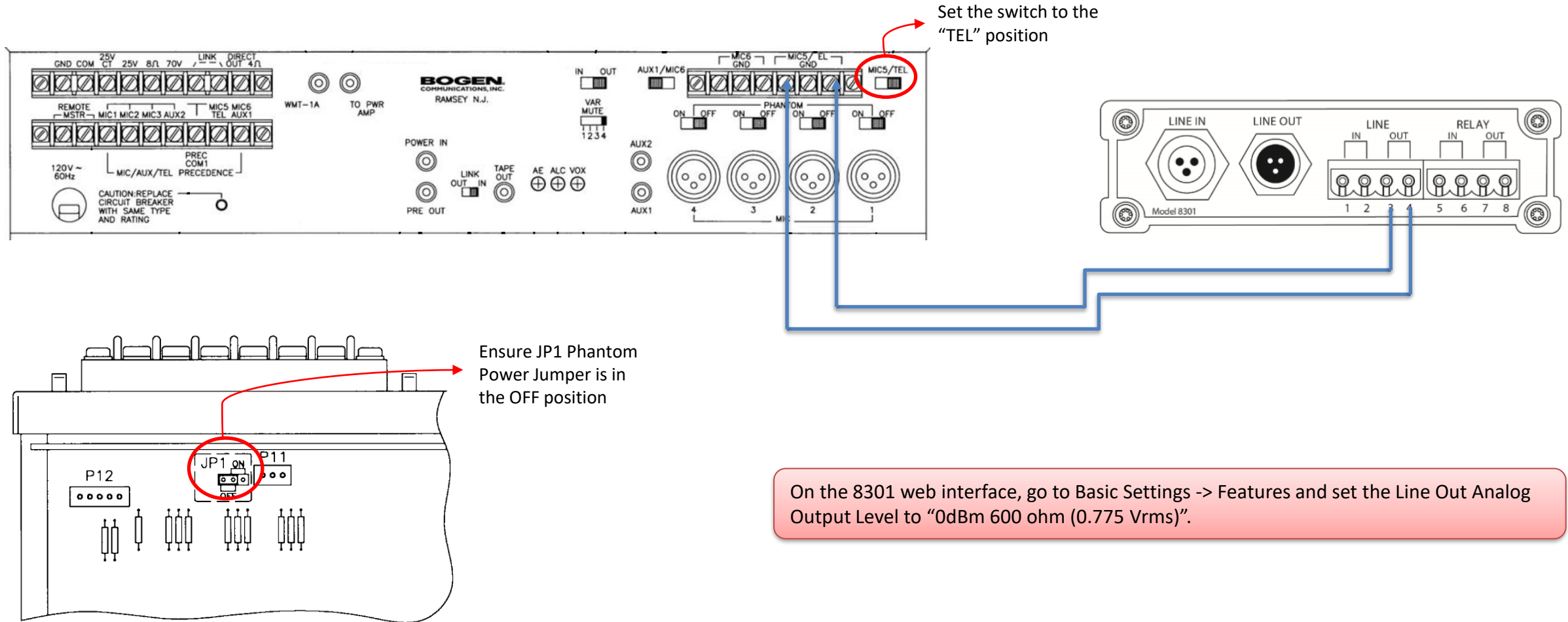

8301 Installation Example with Bogen PCM2000

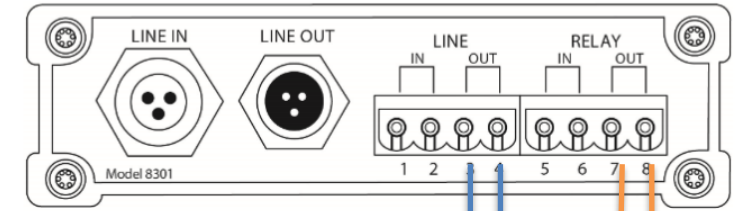
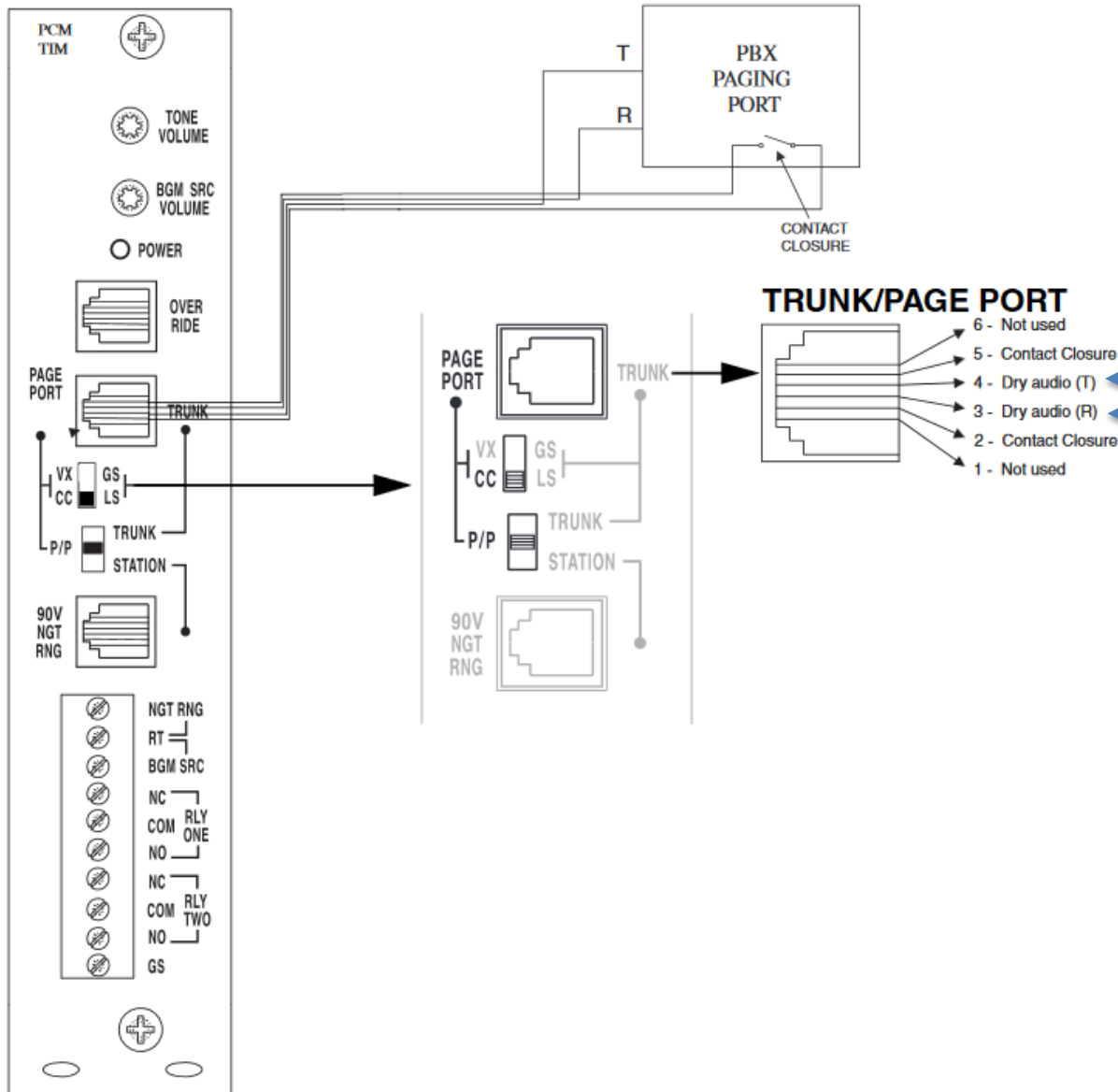

Before connecting, power off PCM2000 system. Set the dip switch as demonstrated above (CC switch down and P/P switch middle).

On the 8301 web interface, go to Basic Settings -> Features and set the Line Out Analog Output Level to "0dBm 600 ohm (0.775 Vrms)".

To play DTMF tones and control the zones, make sure to enable Generate In-Band DTMF Tones (Advanced Settings -> Advanced Audio).

8301 Installation Example with Bogen TPU-35/60/100/250

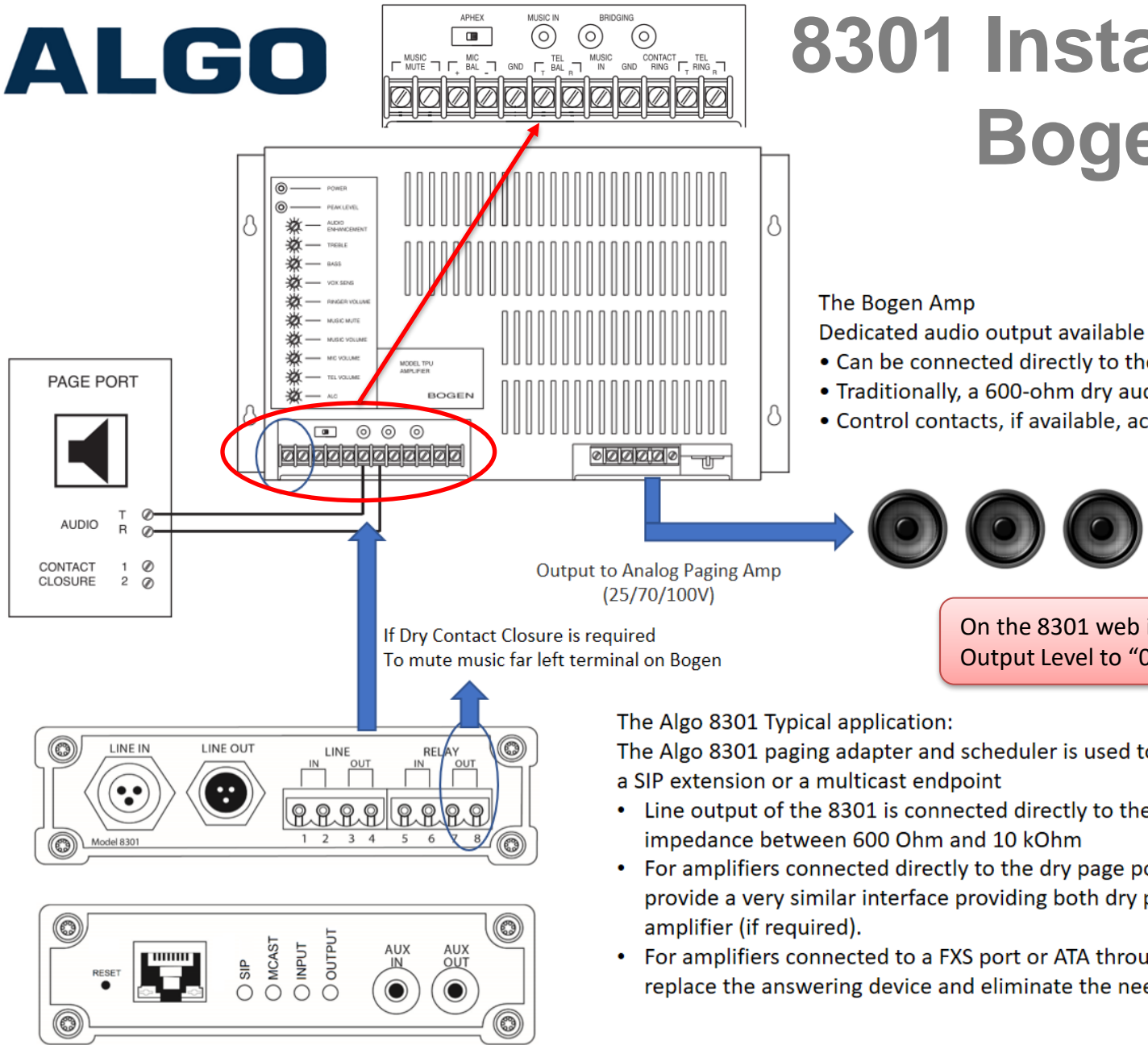

The Bogen Amp

Dedicated audio output available standard on most telephone systems

- Can be connected directly to the input of most amplifiers
- Traditionally, a 600-ohm dry audio signal and a normally open control contact closure
- Control contacts, if available, activate during a page and typically control the muting of background music

The Algo 8301 Typical application:

The Algo 8301 paging adapter and scheduler is used to connect an existing amplifier to UC environment as a SIP extension or a multicast endpoint

- Line output of the 8301 is connected directly to the dry audio input of the amplifier with input impedance between 600 Ohm and 10 kOhm
- For amplifiers connected directly to the dry page port of an existing telephone system, the 8301 will provide a very similar interface providing both dry page audio and dry contact closure to activate the amplifier (if required).
- For amplifiers connected to a FXS port or ATA through a "telephone answering device" the 8301 will replace the answering device and eliminate the need for a FXS port or ATA.

8301 Installation Example with Bogen UTI1

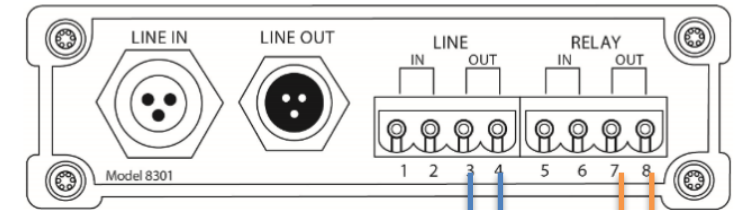
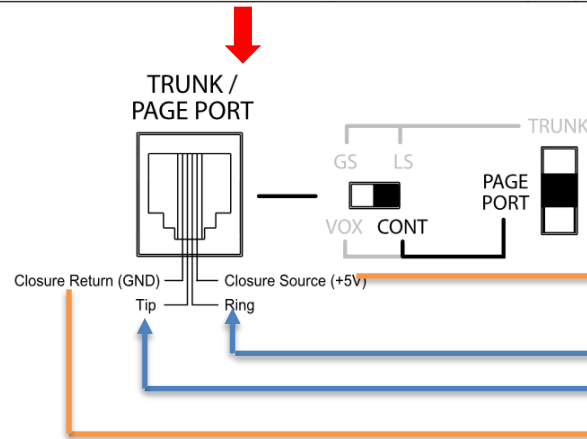
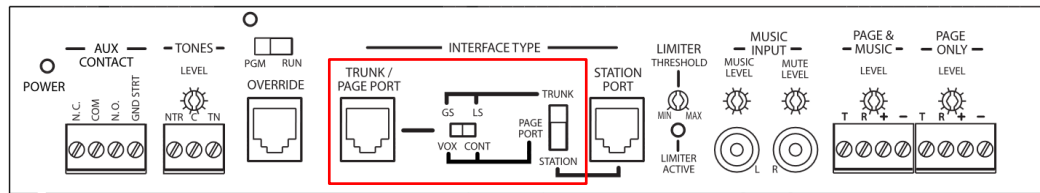

Set the horizontal switch to "CONT" and the vertical to "Page Port".

On the 8301 web interface, go to Basic Settings -> Features and set the Line Out Analog Output Level to "0dBm 600 ohm (0.775 Vrms)".

8301 Installation Example with Crown 135MA/160MA

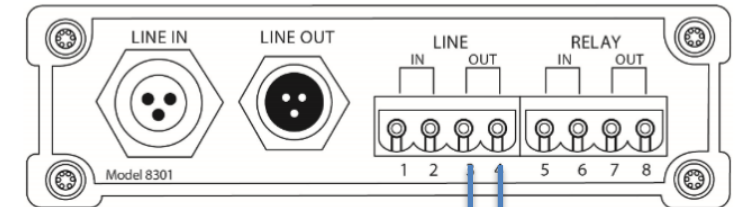
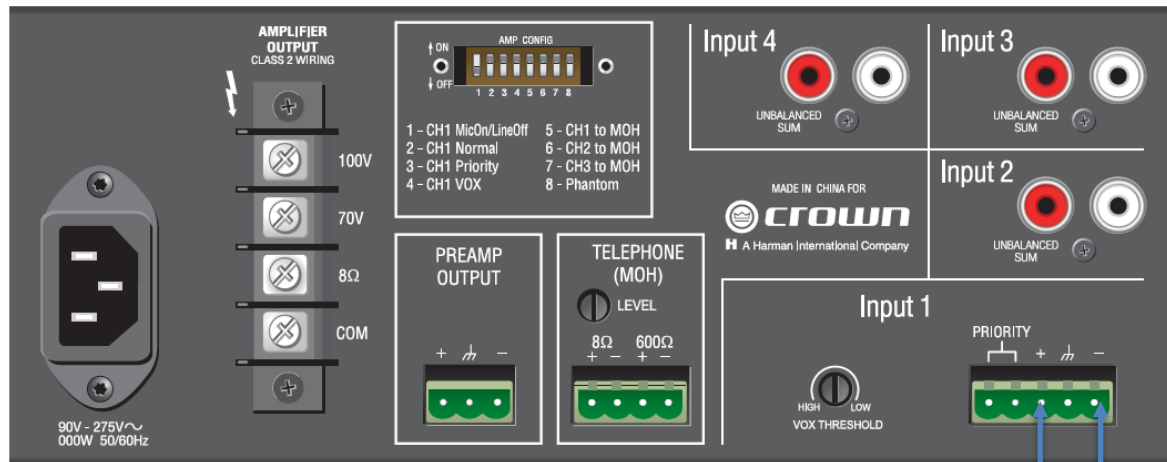

Set switch 1 to "Line" position.

On the 8301 web interface, go to Basic Settings -> Features and set the Line Out Analog Output Level to "0dBv 10k (1.0 Vrms)".

8301 Installation Example with Crown CDI 1000/2000/4000

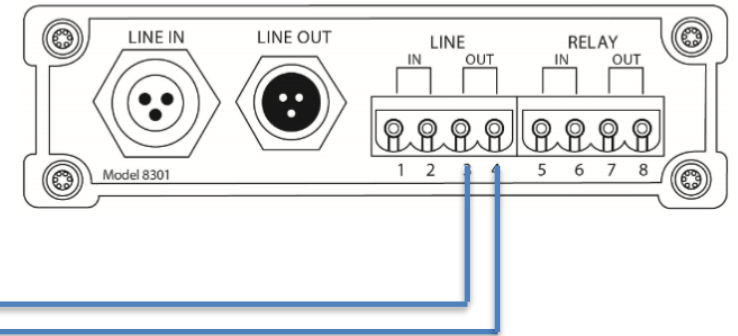
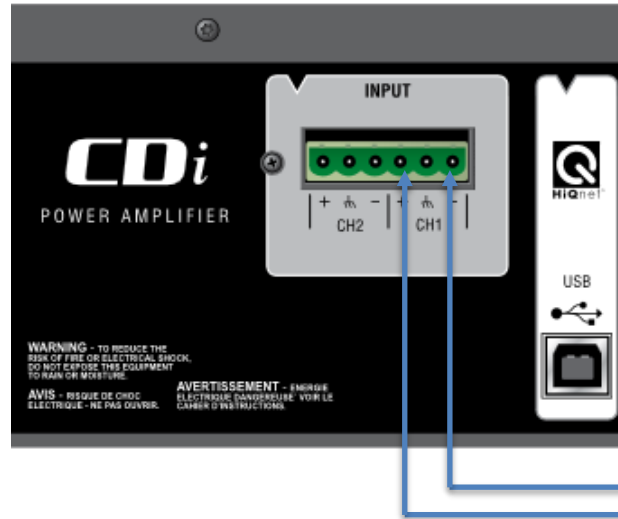

On the 8301 web interface, go to Basic Settings -> Features and set the Line Out Analog Output Level to “+4dBu 10k (1.23 Vrms)”.

Note: Channel 1 or 2 may be used.

8301 Installation Example with Inter-M PA-920/935

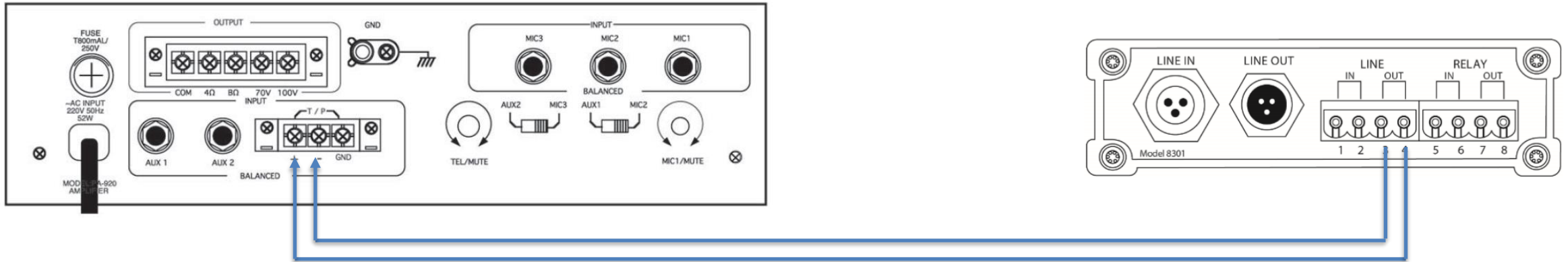

On the 8301 web interface, go to Basic Settings -> Features and set the Line Out Analog Output Level to "0dBm 600 ohm (0.775 Vrms)".

8301 Installation Example with Inter-M PA-60/120/240

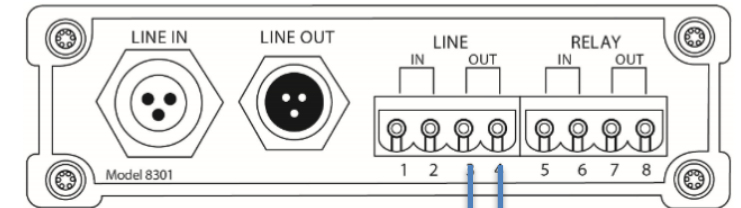
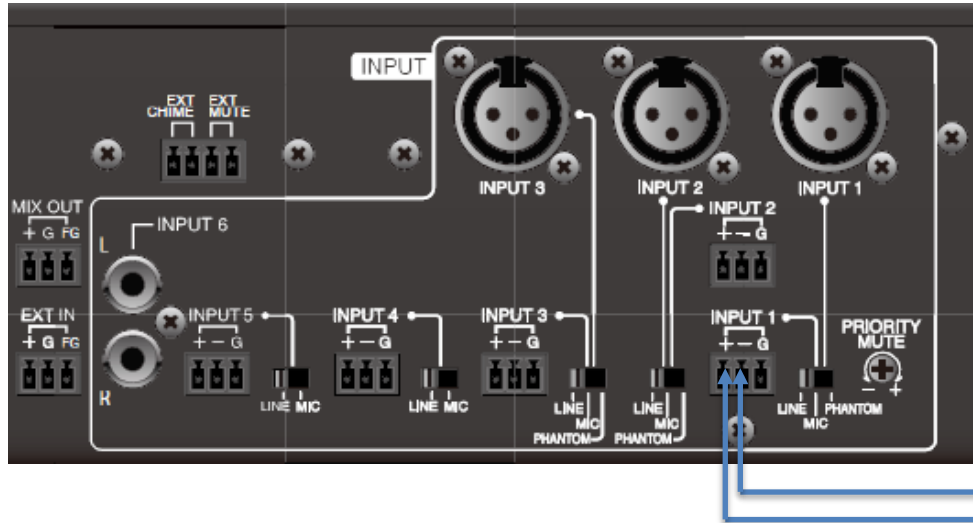

Connect the Line Out pair on the 8301 to the + and – terminals on one of the Inter-M inputs. Move the input selection switch to the “Line” position.

On the 8301 web interface, go to Basic Settings -> Features and set the Line Out Analog Output Level to “0dBm 600 ohm (0.775 Vrms)”.

8301 Installation Example with Paso 3000 Series

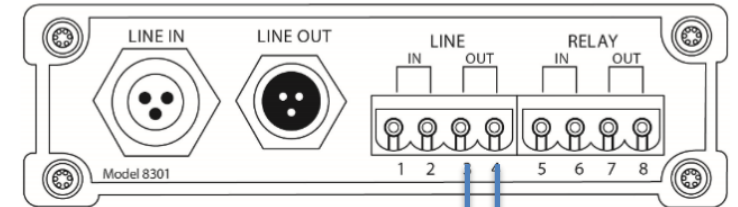
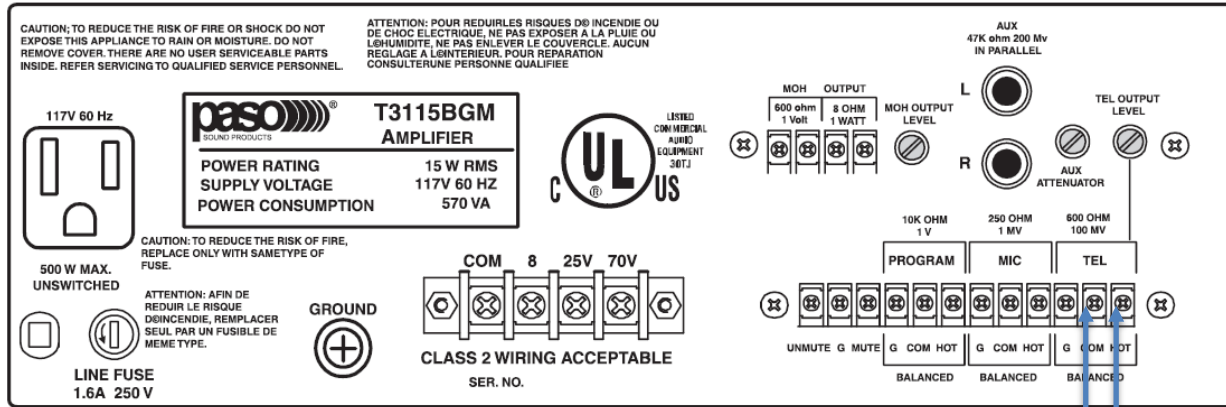

On the 8301 web interface, go to Basic Settings -> Features and set the Line Out Analog Output Level to "0dBm 600 ohm (0.775 Vrms)".

8301 Installation Example with TOA BG-115/130

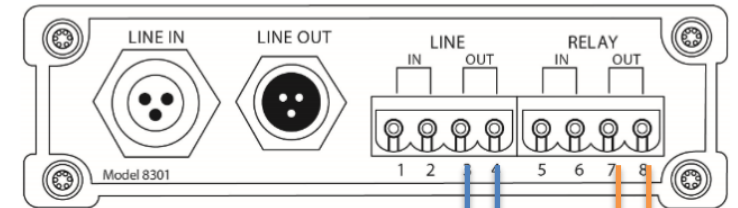
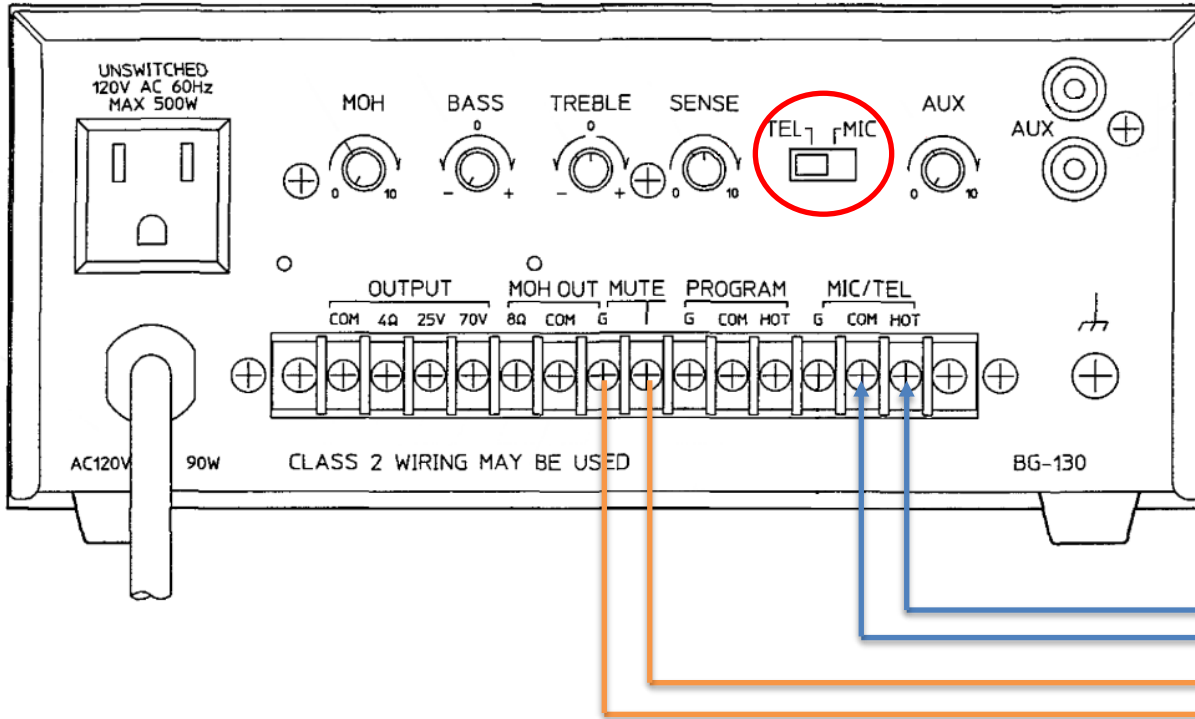

Set the highlighted switch to the TEL position

On the 8301 web interface, go to Basic Settings -> Features and set the Line Out Analog Output Level to "0dBm 600 ohm (0.775 Vrms)".

8301 Installation Example with TOA BG-220/235

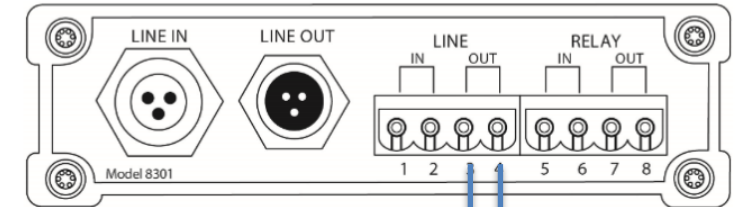
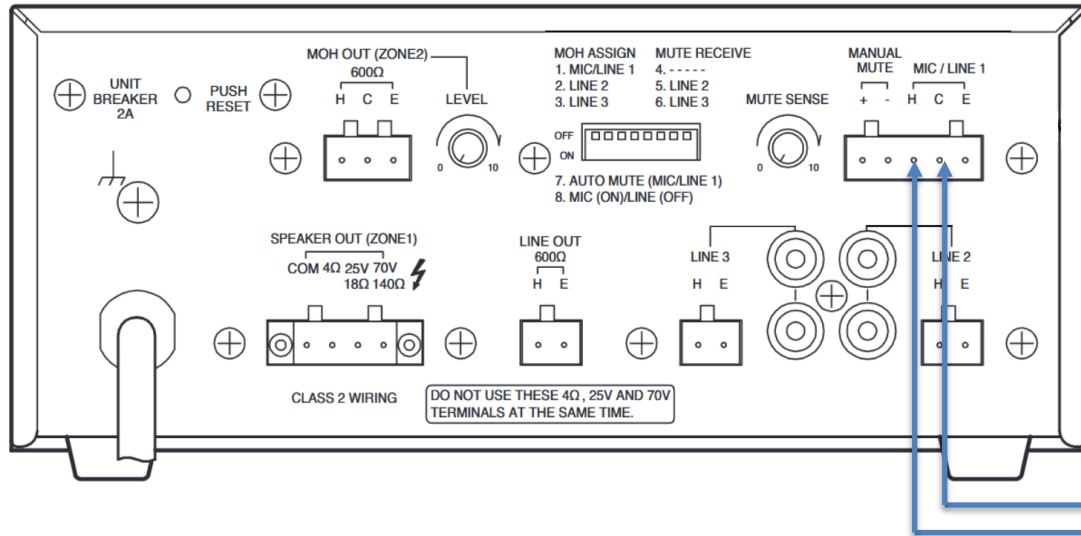

Set DIP switch 8 to the OFF position and be sure to turn off the power before performing this step.

On the 8301 web interface, go to Basic Settings -> Features and set the Line Out Analog Output Level to “-10dBm 600 ohm (0.245 Vrms)”.

8301 Installation Example with TOA BG-1015/1030/1060/1120

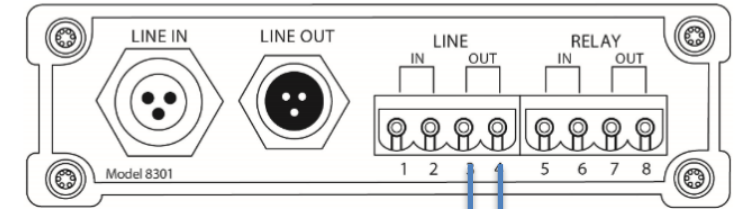
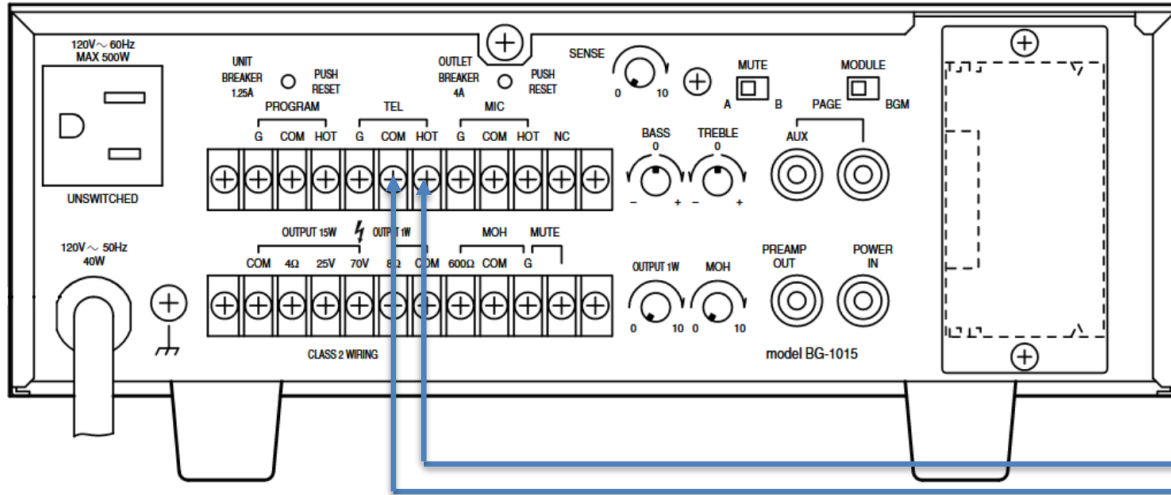

The impedance is set from factory to 10 kΩ. To switch to 600 Ω, change the position of the unit's internal jumper switch JP204 as per diagram below.

On the 8301 web interface, go to Basic Settings -> Features and set the Line Out Analog Output Level to "0dBm 600 ohm (0.775 Vrms)".

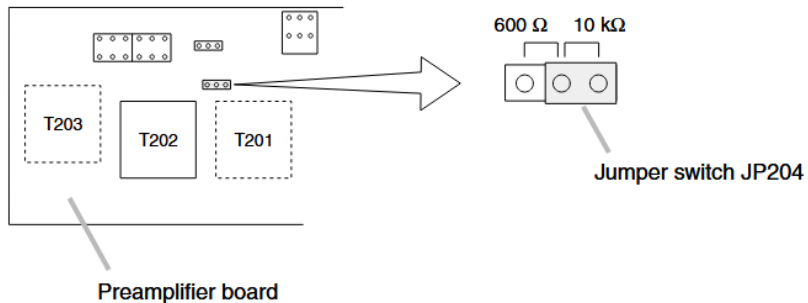

8301 Installation Example with TOA 500 Series

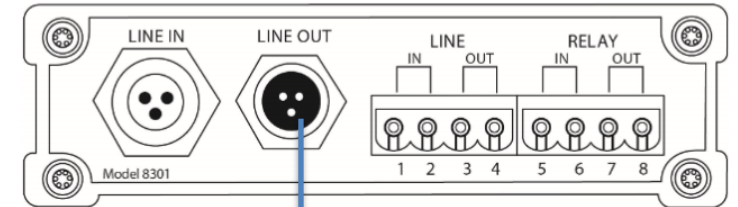

Set the Phantom switch above the input to the off position.

Recommended: Algo 2504 Output XLR-Mini Female to XLR Male

On the 8301 web interface, go to Basic Settings -> Features and set the Line Out Analog Output Level to “-10dBm 600 ohm (0.245 Vrms)”.

8301 Installation Example with Valcom V-2000a

Set the Battery Feed switch off before connecting the 8301

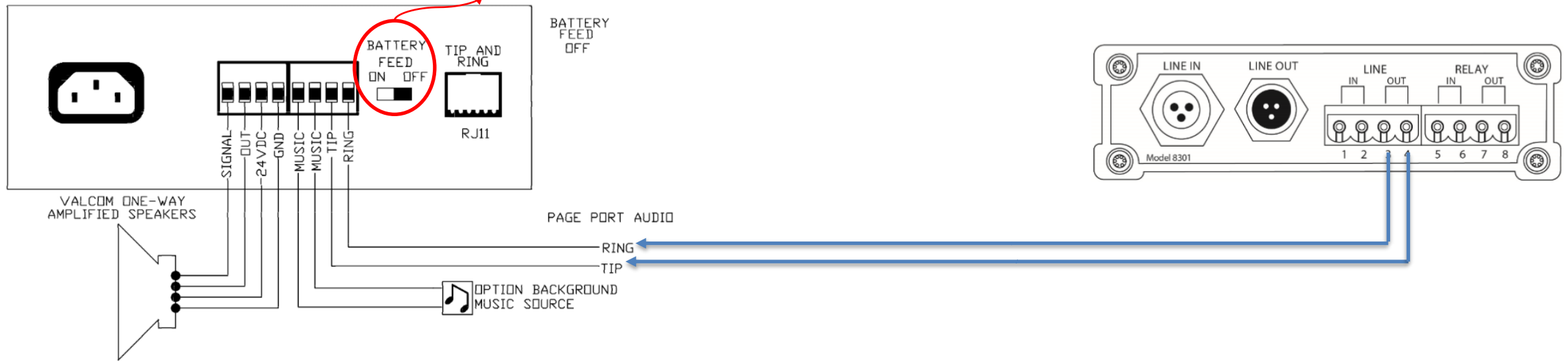

On the 8301 web interface, go to Basic Settings -> Features and set the Line Out Analog Output Level to “-10dBm 600 ohm (0.245 Vrms)”.

8301 Installation Example with Valcom V-2001a

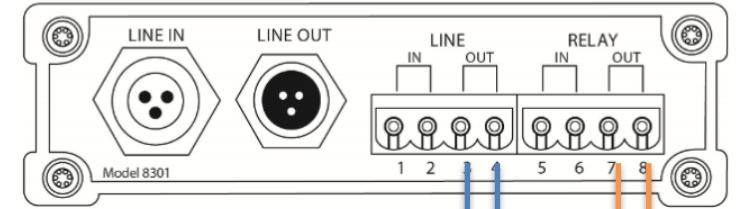

SW1 Off for Page Port Access

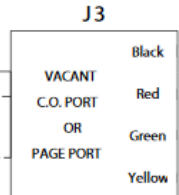
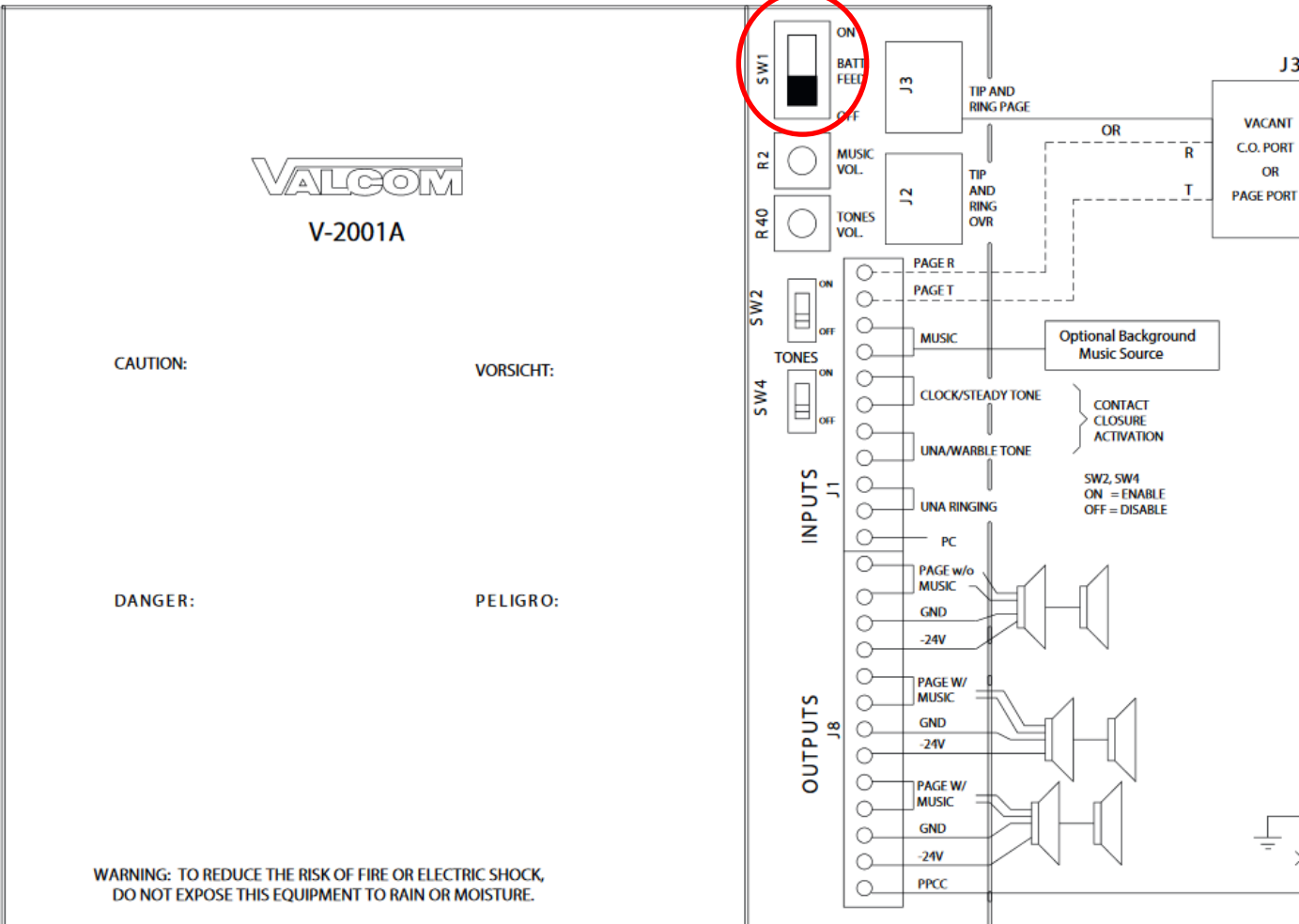

The 8301 Line Out (terminal 3 and 4) connects to either the Tip and J3) using an RJ11 modular connector or the Page T and Page R inputs on the Valcom V-2001A via a 2-wire connection to the terminal strip.

On the 8301 web interface, go to Basic Settings -> Features and set the Line Out Analog Output Level to "-10dBm 600 ohm (0.245 Vrms)".

8301 Installation Example with Valcom V-2003a

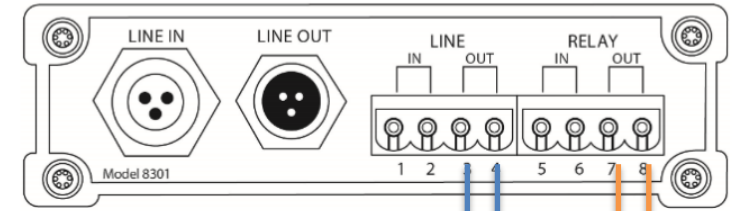
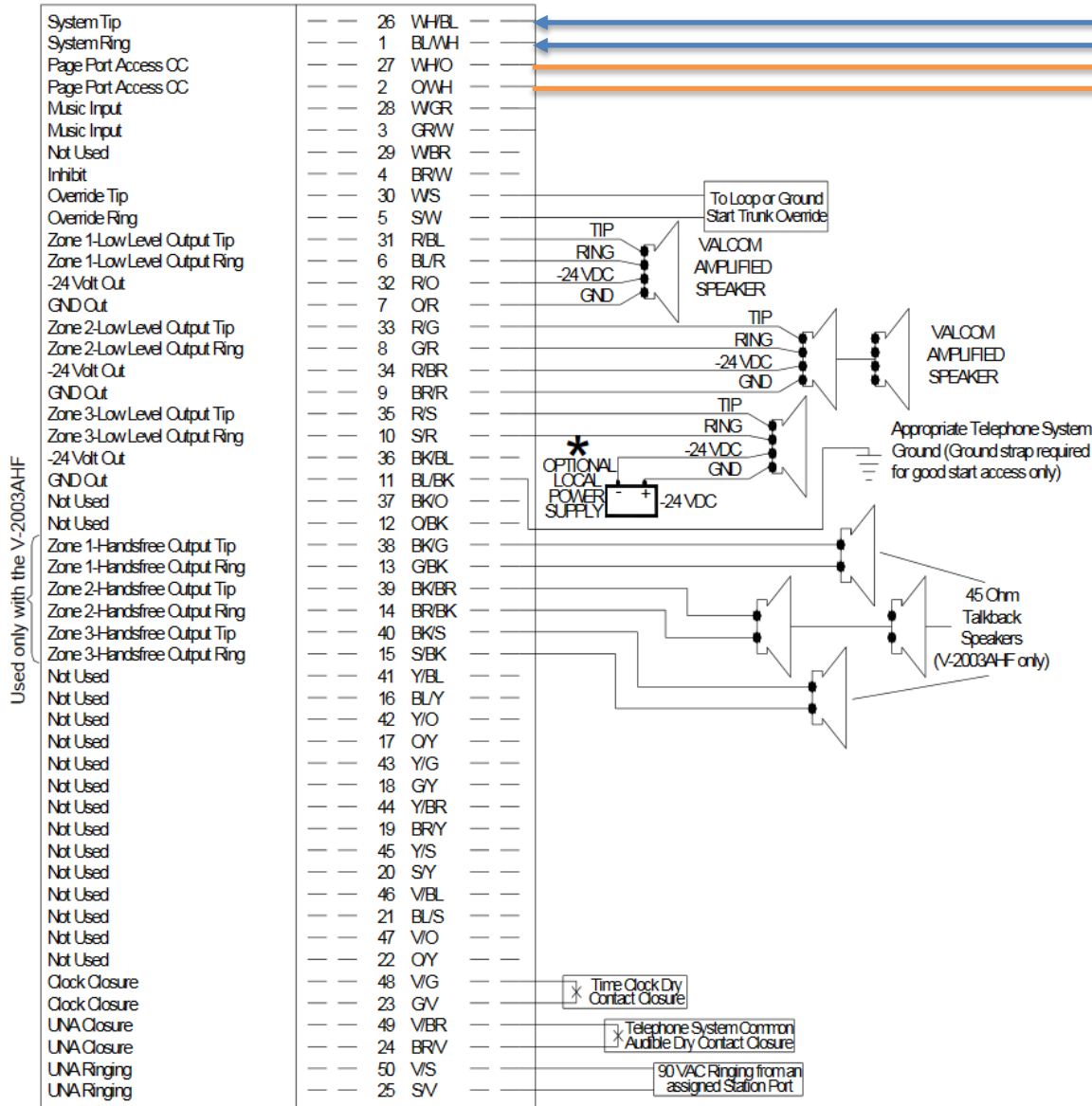

On the Valcom V2003a switch SW3, set 4, 7 and 10 to the off position (up position). Also set SW2 to off position.

On the 8301 web interface, go to Basic Settings -> Features and set the Line Out Analog Output Level to "-10dBm 600 ohm (0.245 Vrms)".

To play DTMF tones and control the zones, make sure to enable Generate In-Band DTMF Tones (Advanced Settings -> Advanced Audio).

8301 Installation Example with Valcom V-2006a

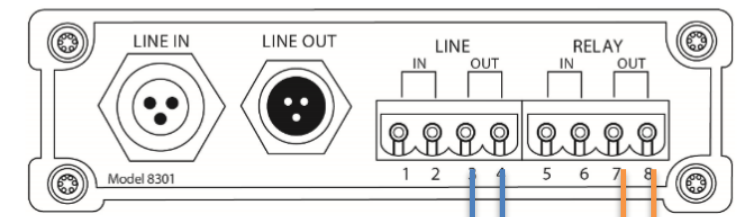
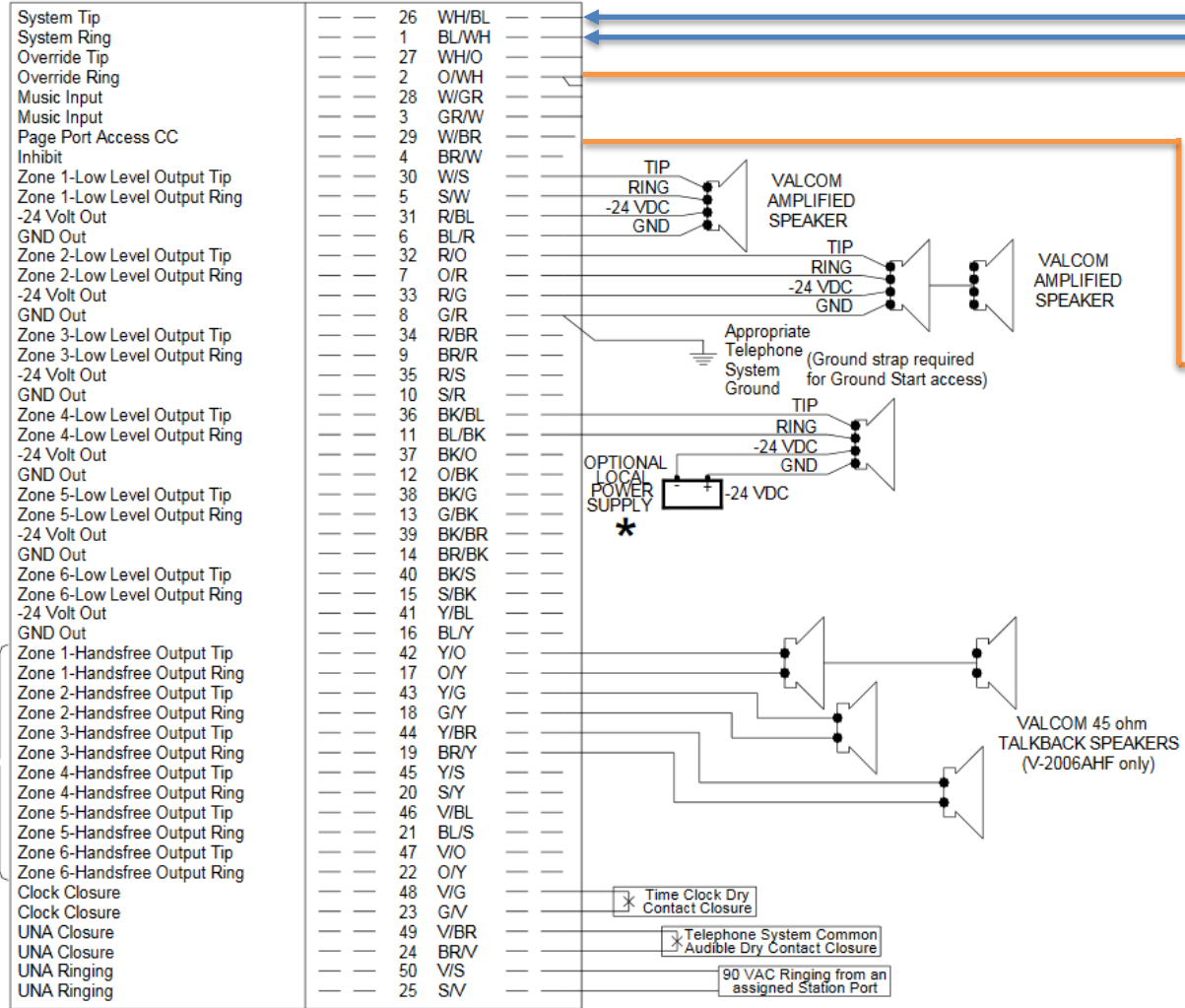

Set the Battery Feed switch to the off position for Page Port access on the V2006a.

On the 8301 web interface, go to Basic Settings -> Features and set the Line Out Analog Output Level to "-10dBm 600 ohm (0.245 Vrms)".

To play DTMF tones and control the zones, make sure to enable Generate In-Band DTMF Tones (Advanced Settings -> Advanced Audio).

Used only with the V-2006AHF

8301 Installation Example with Valcom V-9940

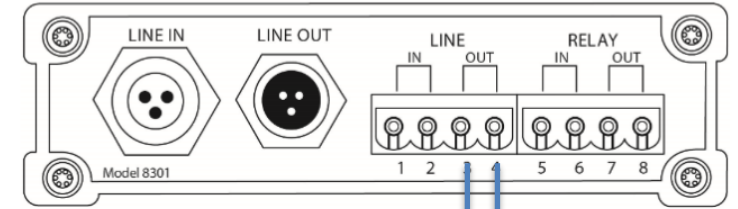
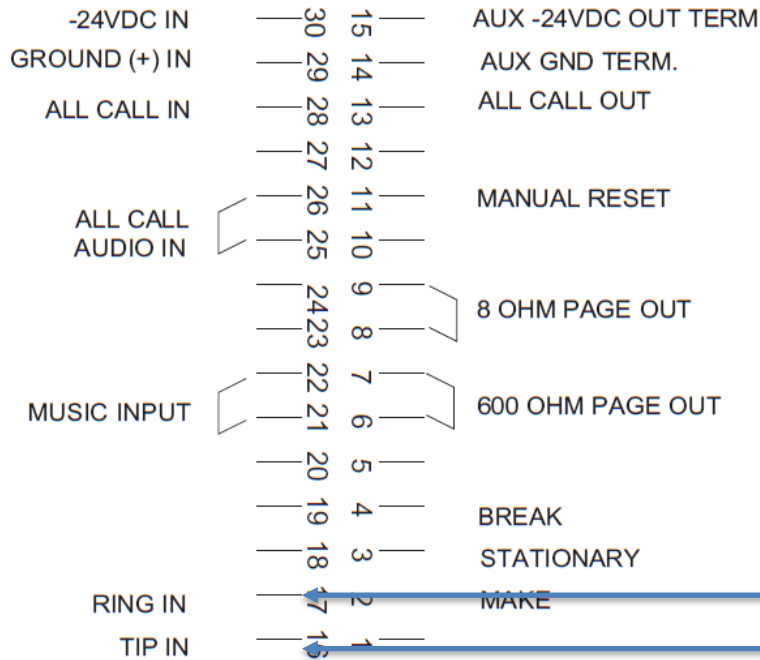

Ensure that only DIP Switches 1 and 8 are ON. If the device is not working try turning DIP Switch 1 OFF.

On the 8301 web interface, go to Basic Settings -> Features and set the Line Out Analog Output Level to “-20dBm 600 ohm (0.077 Vrms)”.

SW	OFF	ON
1	Audio Sense Enable	Time Out Enable
2	Not 1 Sec.	1 Second
3	Not 64 Sec.	64 Seconds
4	Not 32 Sec.	32 Seconds
5	Not 16 Sec.	16 Seconds
6	Not 8 Sec.	8 Seconds
7	Not 4 Sec.	4 Seconds
8	Loop Detect Disable	Loop Detect Enable

8301 Installation Example with Valcom V-9941A

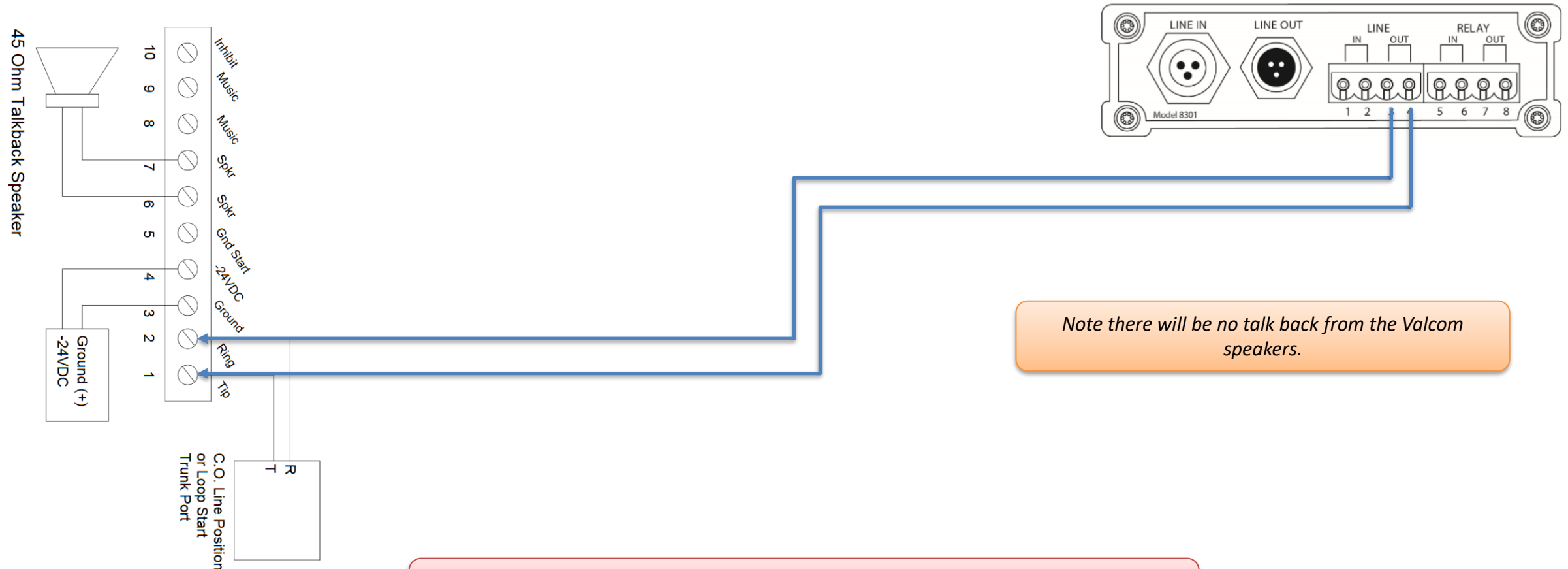

Note there will be no talk back from the Valcom speakers.

On the 8301 web interface, go to Basic Settings -> Features and set the Line Out Analog Output Level to "0dBm 600 ohm (0.775 Vrms)".

8301 Installation Example with Valcom V-1094A

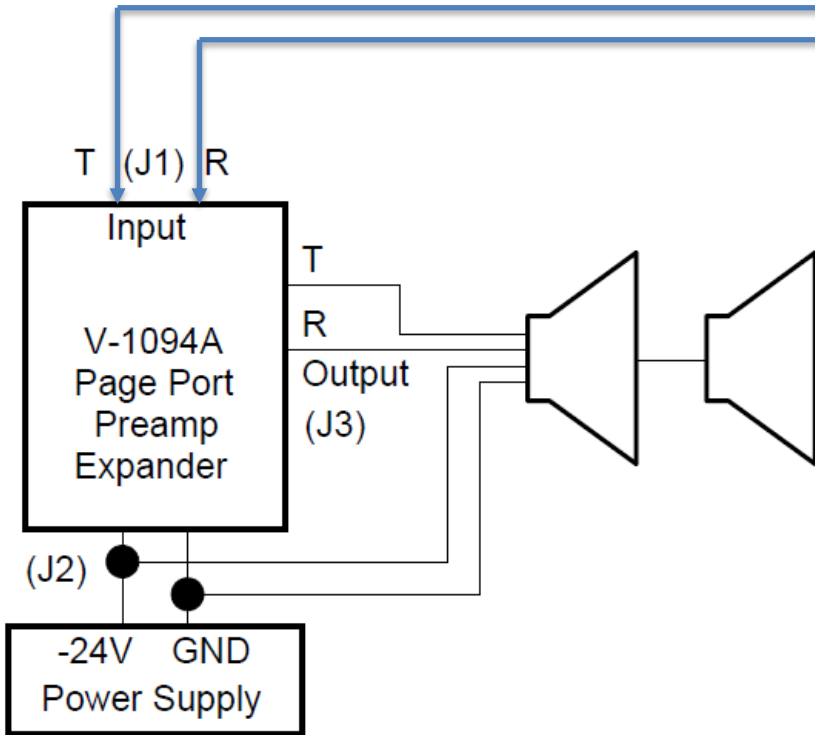
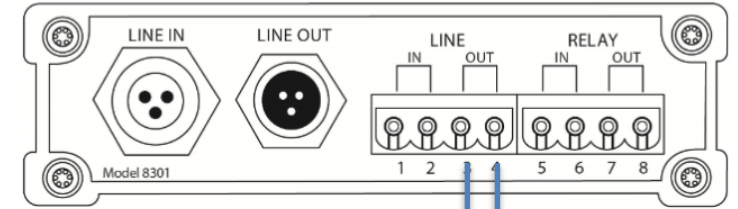

On the 8301 web interface, go to Basic Settings -> Features and set the Line Out Analog Output Level to "0dBm 600 ohm (0.775 Vrms)".

8301 Installation Example with Valcom V-2924A

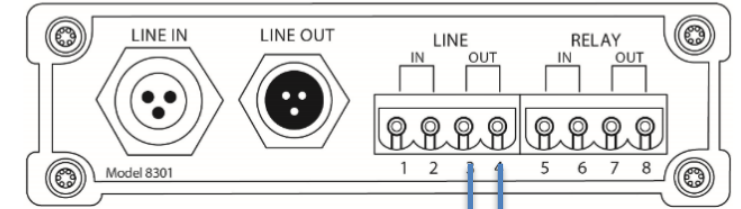

Block P7 - System Inputs

Block P7 - System Inputs			
26	W/BL	Tip - Attendant Tel	Group 1
1	BL/W	Ring - Attendant Tel	
27	W/O	Common Audible C.C.	
2	O/W	Common Audible C.C.	
28	W/GR	BGM Input	
3	GR/W	BGM Input	
29	W/BR	Riot Mode	Group 2
4	BR/W	Riot Mode	
30	W/S	External Tone - Tip	
5	S/W	External Tone - Ring	
31	R/BL	Clock Activate	
6	BL/R	Clock Activate	
32	R/O	Clock Enable C. C.	
7	O/R	Clock Enable C. C.	
33	R/G	Emergency Activate	
8	G/R	Emergency Activate	
34	R/BR	Emergency Enable C. C.	
9	BR/R	Emergency Enable C. C.	
35	R/S	Override Page Port - Tip	
10	S/R	Override Page Port - Ring	
36	BK/BL	Dry Priority Activate	
11	BL/BK	Dry Priority Activate	
37	BK/O	Inhibit	
12	O/BK	Inhibit GND	

Set the Battery Feed switch (SW4) to off for Page Port access.

Note there will be no talkback via the Valcom V-2924A.

On the 8301 web interface, go to Basic Settings -> Features and set the Line Out Analog Output Level to “-10dBm 600 ohm (0.245 Vrms)”..

To play DTMF tones and control the zones, make sure to enable Generate In-Band DTMF Tones (Advanced Settings -> Advanced Audio).

8301 Installation Example with Valcom VIP-801A



On the 8301 web interface, go to Basic Settings -> Features and set the Line Out Analog Output Level to “-10dBm 600 ohm (0.245 Vrms)”..

8301 Installation Example with Viking PA-2A

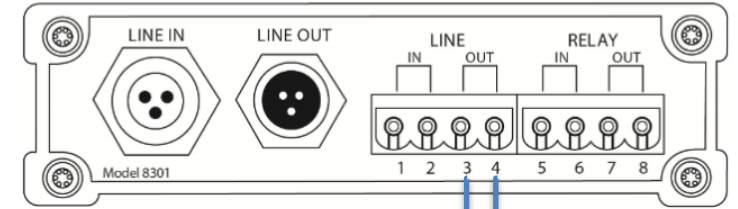
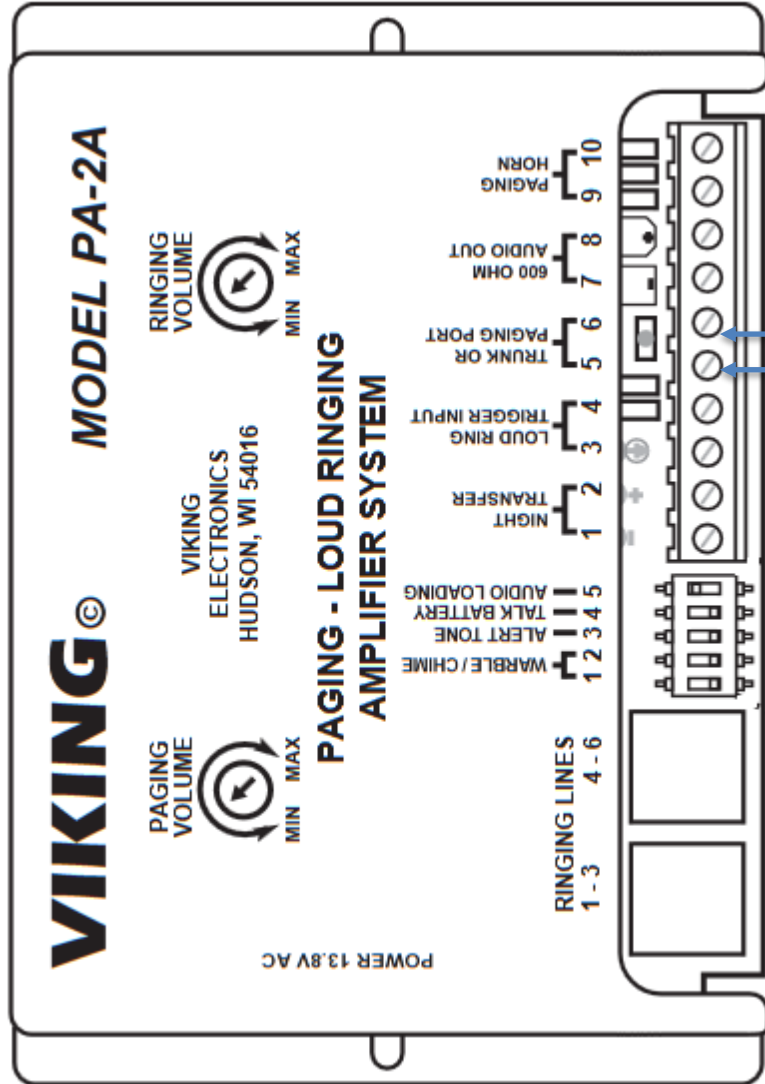

Set DIP switch 4 for talk battery to the OFF position on the PA-2A to prevent damaging the 8301.

On the 8301 web interface, go to Basic Settings -> Features and set the Line Out Analog Output Level to "0dBm 600 ohm (0.775 Vrms)".

8301 Installation Example with Viking PA-15

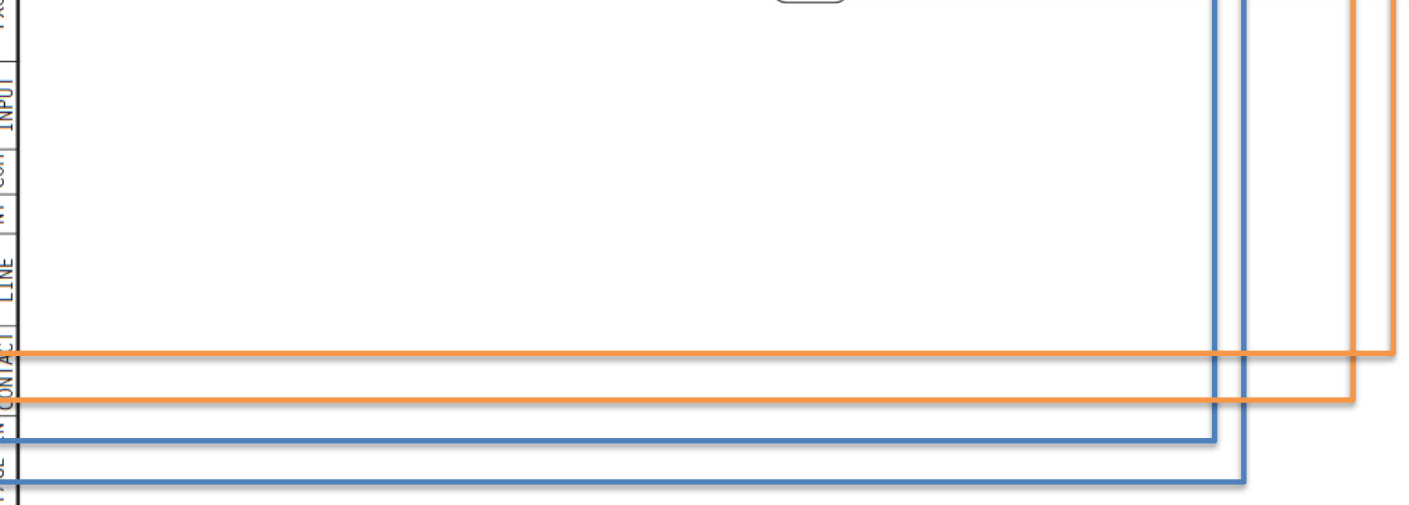
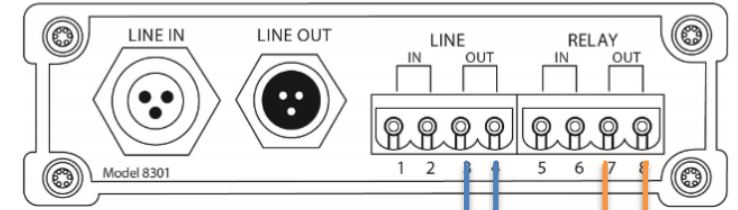
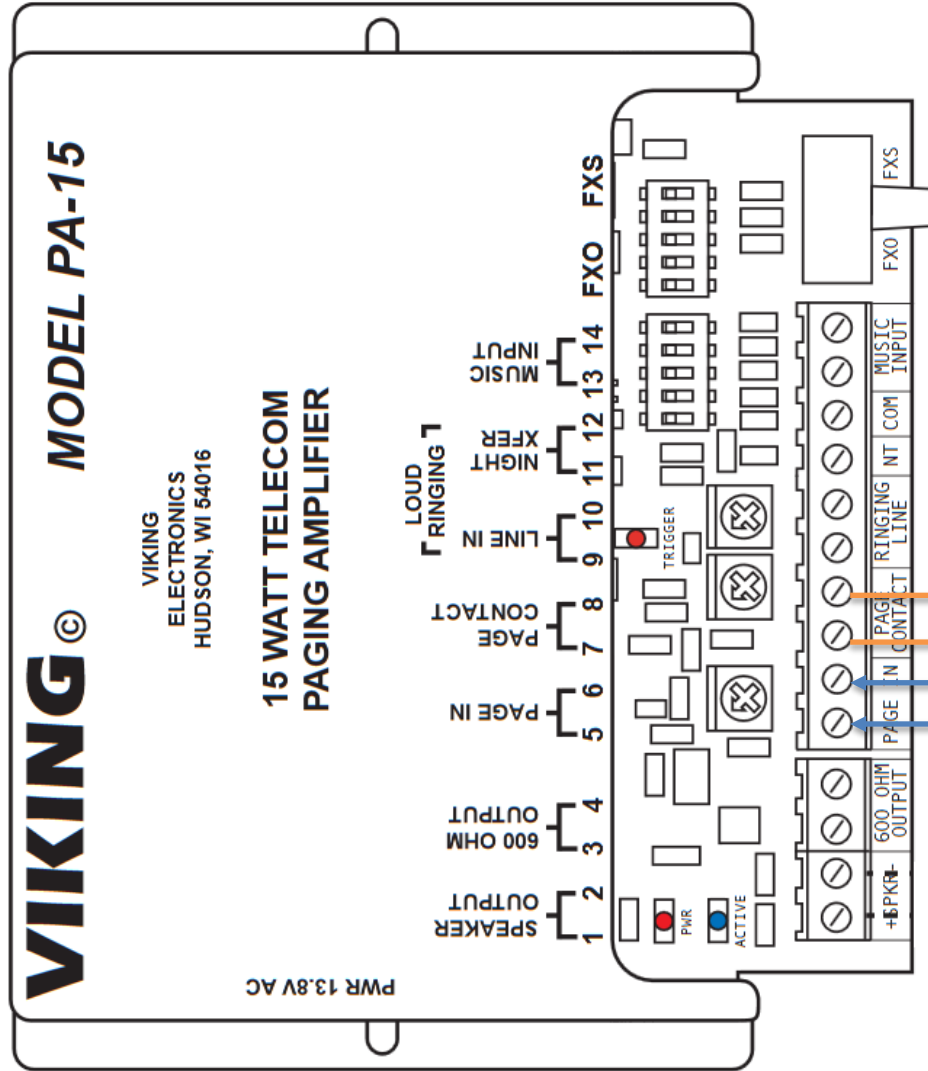

On the 8301 web interface, go to Basic Settings -> Features and set the Line Out Analog Output Level to "0dBm 600 ohm (0.775 Vrms)".

8301 Installation Example with Viking PA-60

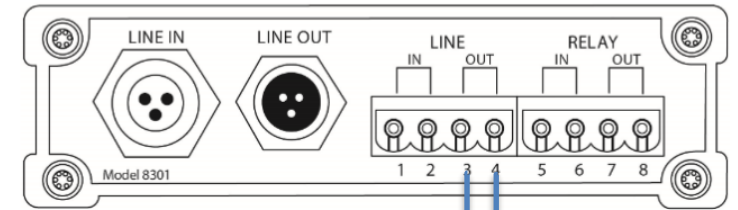
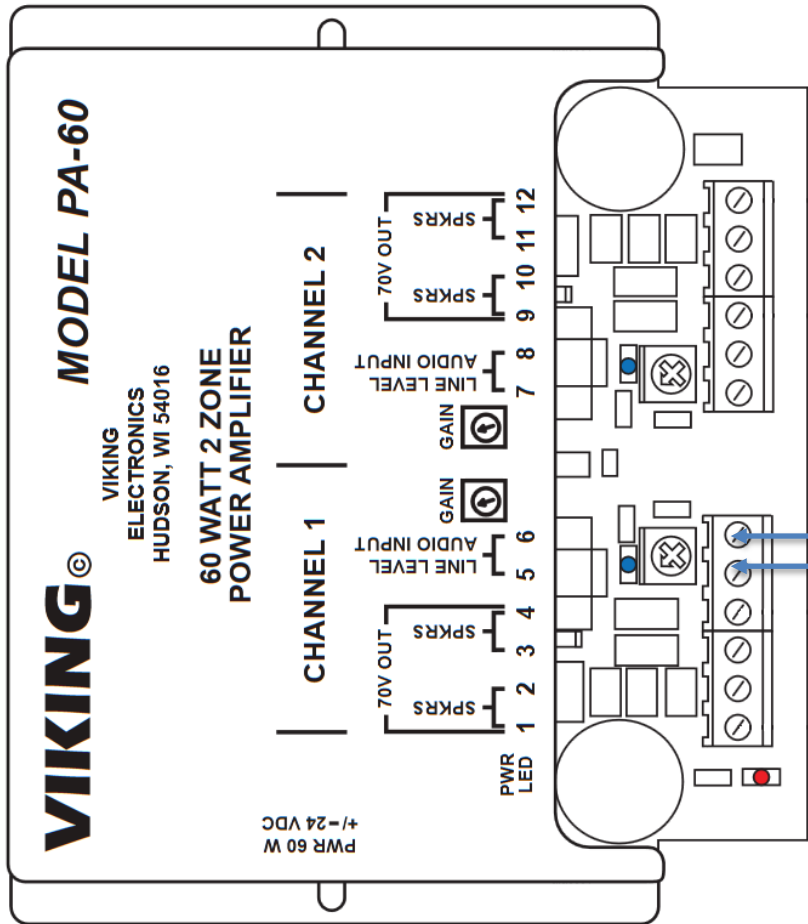

On the 8301 web interface, go to Basic Settings -> Features and set the Line Out Analog Output Level to "0dBm 600 ohm (0.775 Vrms)".

If there are speakers connected to both channels, then an 8301 per channel will be required. One 8301 can be SIP registered and configured to Multicast to the second for zone paging including All Call.

ALGO

Please contact us if there are additional amplifier models you wish to see included in this guide.



Support (604) 454-3792
support@algosolutions.com